

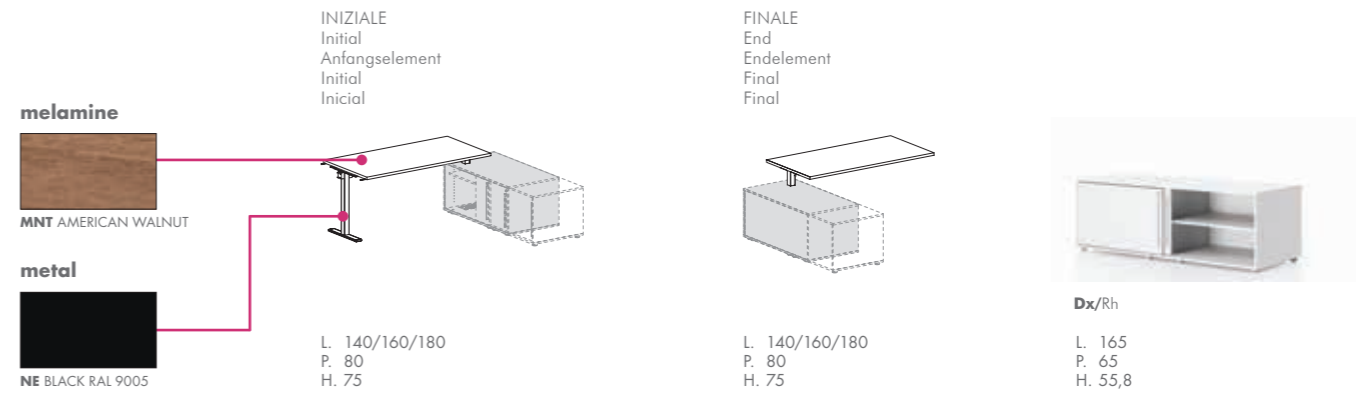

FREZZA

POP,
operative system

pop tee



melamine

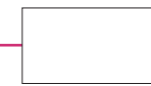

MBI WHITE

metal



BI WHITE RAL 9010

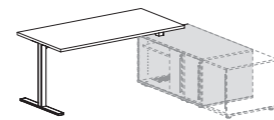

L. 140/160/180
P. 80
H. 75



Dx/Rh

L. 165
P. 65
H. 55,8



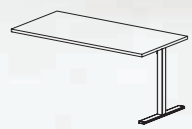

L. 120/140/160/180
P. 80
H. 75



L. 40
P. 80
H. 75

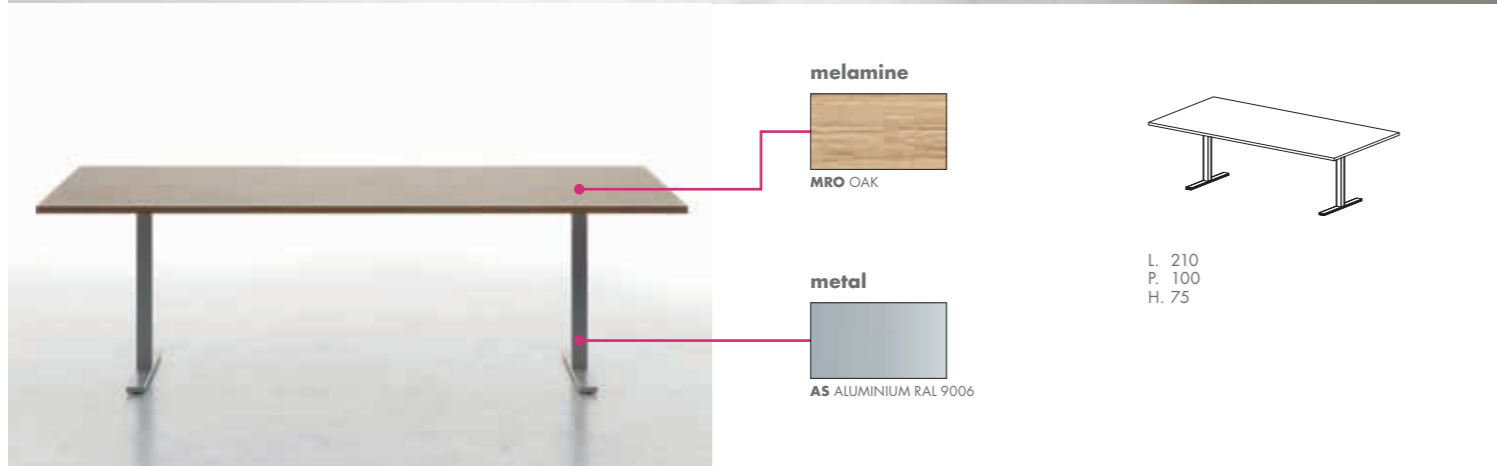

FINITURE

FINISHES/AUSFÜHRUNGEN/FINITIONS/ACABADOS



product information

gambe metalliche

METAL LEGS
METALLBEINE
PIEDS EN MÉTAL
PATAS EN METAL

metal



BI WHITE
RAL 9010



AS ALUMINIUM
RAL 9006



NE BLACK
RAL 9005

piano/gonna

TOP/ MODESTY PANEL
PLATTE/SICHTBLENDE
PLATEAU/ VOILE DE FOND
SOBRE/ FALDON

melamine



MBI WHITE



MGT ICE GREY

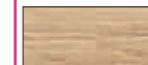

MRO OAK



MNT AMERICAN WALNUT

vasca di cablaggio

WIRING DUCT
KABELKANAL
BAC CÂBLAGE
BANDEJA DE ELETRIFICACIONES

metal



BI WHITE
RAL 9010



AS ALUMINIUM
RAL 9006



NE BLACK
RAL 9005

schermi

SCREEN
TRENNSCHIRM
PANNEAU-ÉCRAN
PANTALLAS

melamine



MBI WHITE



MGT ICE GREY

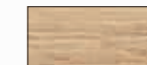

MRO OAK



MNT AMERICAN WALNUT

glass



V0C FROSTED GLASS

fabric



XF KING FLEX



JT JET



SM STEP MELANGE



www.frezza.com

